

Vandal Resistant CP-BS J/V Shower Set w/ V/R Shower

PRODUCT CODES

- 49976

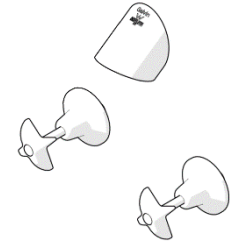

SPECIFICATIONS

- Vandal resistant handle featuring a locking ring to secure the handle to the spindle
- Chrome plate finish for easy cleaning and added durability
- Front or rear fixing
- Vandal resistant shower rose
- Complies with NSW Education EFSG Guidelines
- Primarily designed for use in busy public areas where a long lasting tap is essential

IMPORTANT: All Shower Sets are tested in accordance with AS/NZS 3718 and leave our premises in good working order

TECHNICAL DATA

Inlet		1/2" BSP - Female
Outlet		Shower Rose
Headwork		N/A
Working Pressure Range (kPa)	Min	150
	Max	500
Working Temperature Range (°C)	Min	5
	Max	70
Nominal Flow Rate (LPM)		8.4
Construction		Brass
Finish		Chrome

NOTE: Galvin Engineering continually strive to improve their products. Specifications may change without notice.

PRE-INSTALLATION

MOUNTING DETAILS – Wall Top Assembly

Note: Before installation, all lines must be flushed. We recommend that a line strainer be installed prior to drinking taps to eliminate any foreign material.

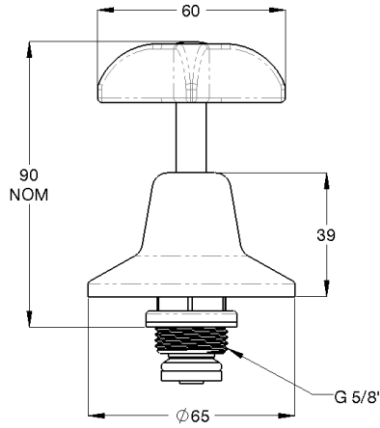

MOUNTING DETAILS – Shower Rose

- The rough in details show correct fitment of the Vandal Resistant Shower unit.
- Recommended installation height above floor level is 2 metres (6'6").
 - Installation can be either Front or Back mounted

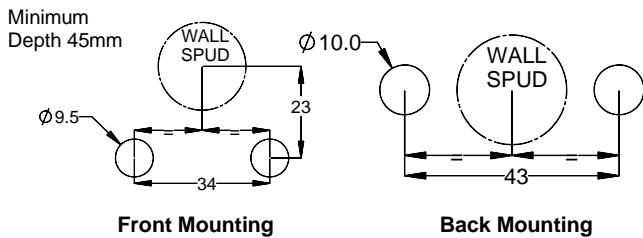
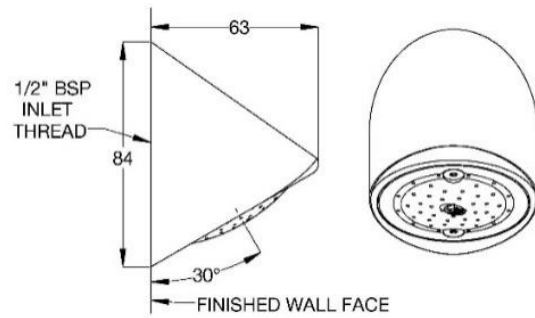

INSTALLATION – SHOWER ROSE

INSTALLATION COMPLIANCE: Galvin Engineering products must be installed in accordance with these installation instructions and in accordance with AS/NZS 3500, the PCA and your local regulatory requirements. Water and/or electrical supply conditions must also comply to the applicable national and/or state standards. Failing to comply with these provisions shall void the product warranty and may affect the performance of the product.

IMPORTANT: Whilst our product designs take into account a broad range of installation types and surfaces, it is important that surfaces which fixtures are mounted to are flat and free from defect. Additionally, ensure any protruding connecting thread is square to the wall so that the outlet sits flat against the wall when installed, ensuring that there are no gaps between the wall and outlet. This is especially important when installing product ranges that have been designed for correctional and health facilities, where special attention is required to minimise ligature points and areas for concealment of contraband. In addition to ensuring the products are fitted securely and in accordance with the following instructions, consideration shall be given to the use of non-pick mastics such as BASF Sonolastic “Ultra” to ensure a high quality and safe installation.

FRONT MOUNTING (Option #1)

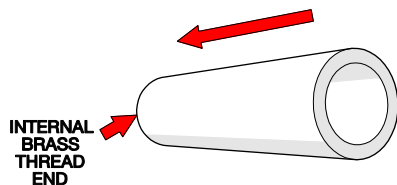

1. Fit rawlnuts

- Drill holes as detailed in the mounting details (Front Mounted).
- Push the two supplied rawlnuts into the drilled holes in the wall.

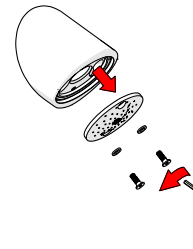

2. Remove shower face

- Remove the shower face using the supplied tamper resistant hex key.

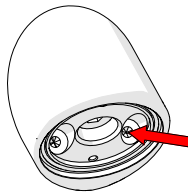

3. Drill out the dimples

- Drill out the dimples (Ø5.0mm) in the body to allow the screws to push through

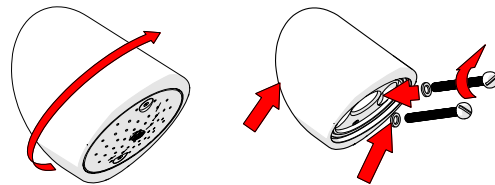

4. Fit shower body

- Fit the shower body onto ½” wall spud, ensuring to apply thread tape or sealant to create a water tight seal.
- The gap between the back face of the shower and the wall must be kept to an absolute minimum.
- Fit the two screws through the drilled holes and tighten them into the rawlnuts.

Ensure the provided nylon washers are under the screw head.

Note: Suitable sealant should be used between the wall and the shower body to create a seal, especially in high risk installation.

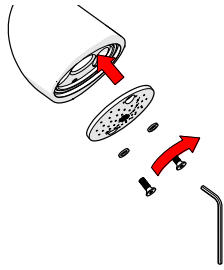

5. Refit shower face

- Refit the shower face using the supplied tamper resistant hex key, ensuring the nylon washers are under the screw head. Ensure o-ring seal is under the shower face

BACK MOUNTING (Option #2)

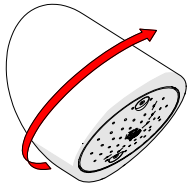

1. Fit shower body

- Drill holes through wall as detailed in mounting details (Back Mounting)
- Fit the shower body onto 1/2" wall spud, ensuring to apply thread tape or sealant to create a water tight seal.

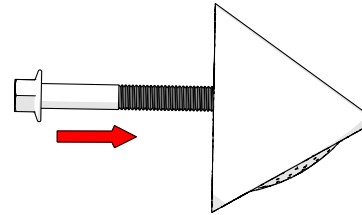

2. Secure the body

- From the rear, secure the body with 3/8" Whitworth bolts.
- The gap between the back face of the shower and the wall must be kept to an absolute minimum.

Note: Suitable sealant should be used between the wall and the shower body to create a seal, especially in high risk installation.

INSTALLATION – WALL TOP ASSEMBLY

INSTALLATION COMPLIANCE: Galvin Specialised products must be installed in accordance with these installation instructions and in accordance with AS/NZS 3500, the PCA and your local regulatory requirements. Water and/or electrical supply conditions must also comply to the applicable national and/or state standards. Failing to comply with these provisions shall void the product warranty and may affect the performance of the product.

IMPORTANT: Whilst our product designs take into account a broad range of installation types and surfaces, it is important that surfaces which fixtures are mounted to are flat and free from defect. This is especially important when installing product ranges that have been designed for correctional and health facilities, where special attention is required to minimise ligature points and areas for concealment of contraband. In addition to ensuring the products are fitted securely and in accordance with the following instructions, consideration shall be given to the use of non-pick mastics such as BASF Sonolastic "Ultra" to ensure a high quality and safe installation.

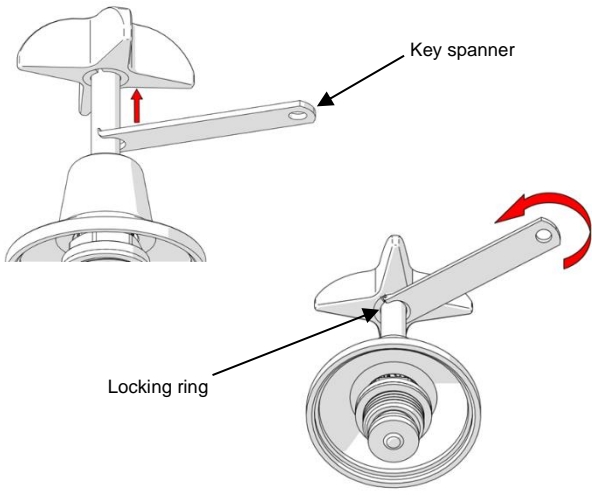
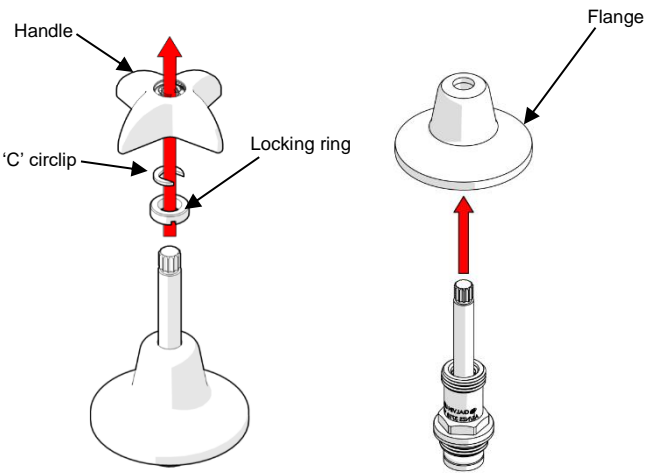
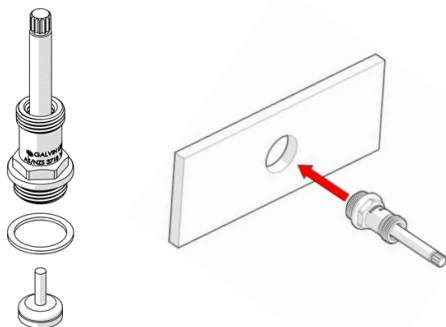
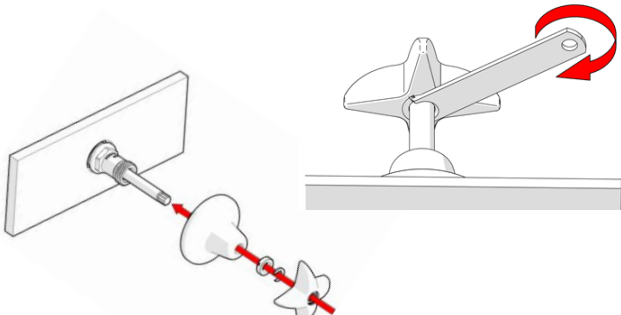
 <p>1. Remove locking ring</p> <ul style="list-style-type: none"> Using supplied key spanner, unscrew the handle assembly locking ring as shown. 	 <p>2. Disassemble</p> <ul style="list-style-type: none"> Remove the handle, then 'C' circlip and locking ring. Unscrew the flange.
 <p>3. Fit top assembly</p> <ul style="list-style-type: none"> Fit top assembly ensuring the tap washer and jumper valve is in place. 	 <p>4. Re-assemble</p> <ul style="list-style-type: none"> Fit the assembly components by reversing steps 2 & 1 as shown.

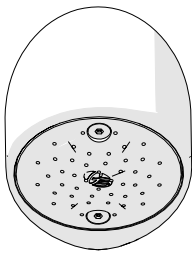
TESTING	
	<ul style="list-style-type: none"> Turn on water supply, inspect the tap and check for any leaks. <p>Note: Never operate without a flow restrictor, as Vandal Resistant Shower Rose will deliver full mains pressure with unrestricted flow.</p>

TROUBLESHOOTING

PROBLEM	CAUSE	RECTIFICATION
Taps are dripping water	Ceramic cartridge is worn or damaged	Remove and inspect the cartridge, remove debris and /or replace cartridge if damaged
Water is not flowing from tap	Water supply is turned off	Turn on water supply
Shower is dripping water	Head-works are worn or damaged	Remove and inspect the head-works, remove debris and/or replace head parts if damaged
Inconsistent flow	Blocked flow restrictor	Remove flow regulator from body and remove debris. Install an inline strainer to stop further blockages.
Leak from behind body	Insufficient sealant	Apply more sealant
Rate of flow inadequate	The flow restrictor may not be satisfactory due to inadequate supply pressure	Remove flow restrictor and replace with a flow restrictor of different capacity to suit (available from Galvin Engineering)

WARRANTY

The warranty set forth herein is given expressly and is the only warranty given by the Galvin Engineering Pty Ltd. With respect to the product, Galvin Engineering Pty Ltd makes no other warranties, express or implied. Galvin Engineering Pty. Ltd. hereby specifically disclaims all other warranties, express or implied, including but not limited to the implied warranties of merchantability and fitness for a particular purpose.

Galvin Engineering Pty Ltd products are covered under our manufacturer’s warranty available for download from www.galvinengineering.com.au Galvin Engineering Pty Ltd expressly warrants that the product is free from operational defects in workmanship and materials for the warranty period as shown on the schedule in the manufacturer’s warranty. During the warranty period, Galvin Engineering will replace or repair any defective products manufactured by Galvin Engineering without charge, so long as the terms of the Manufacturer’s warranty are complied with.

The remedy described in the first paragraph of this warranty shall constitute the sole and exclusive remedy for breach of warranty, and Galvin Engineering Pty Ltd shall not be responsible for any incidental, special or consequential damages, including without limitation, lost profits or the cost of repairing or replacing other property which is damaged if this product does not work properly, other costs resulting from labour charges, delays, vandalism, negligence, fouling caused by foreign material, damage from adverse water conditions, chemical, electrical or any other circumstances over which Galvin Engineering has no control. This warranty shall be invalidated by any abuse, misuse, misapplication, improper installation or improper maintenance or alteration of the product.

Within Australia: 1300 514 074 Outside Australia: P: +61 (0)8 9338 2344

F: +61 (0)8 9338 2340

sales@galvinengineering.com.au

www.galvinengineering.com.au

ABN: 78 008 719 382

PERTH | SYDNEY | MELBOURNE | BRISBANE | ADELAIDE

